

Absolute Maximum Ratings		Values	Units
Symbol	Conditions ¹⁾		
V _{CES}		600	V
V _{CGR}	R _{GE} = 20 kΩ	600	V
I _C	T _{case} = 25/70 °C	260 / 200	A
I _{CM}	T _{case} = 25/70 °C; t _p = 1 ms	450 / 400	A
V _{GES}		± 20	V
P _{tot}	per IGBT, T _{case} = 25 °C	875	W
T _j , (T _{stg})		-40 ... +150 (125)	°C
V _{isol}	AC, 1 min.	2 500	V
humidity	DIN 40 040	Class F	
climate	DIN IEC 68 T.1	40/125/56	
Inverse Diode			
I _F = -I _C	T _{case} = 25/80 °C	200 / 135	A
I _{FM} = -I _{CM}	T _{case} = 25/80 °C; t _p = 1 ms	450 / 400	A
I _{FSM}	t _p = 10 ms; sin.; T _j = 150 °C	1 400	A
I ² t	t _p = 10 ms; T _j = 150 °C	9 800	A ² s

SEMITRANS® M Superfast NPT-IGBT Modules

SKM 200 GB 063 D

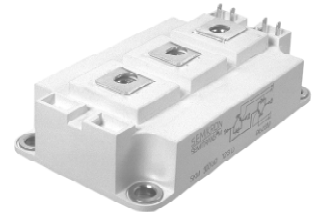

SEMITRANS 3

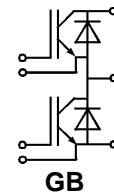

Features

- N channel, homogeneous Silicon structure (NPT- Non punch-through IGBT)
 - Low tail current with low temperature dependence
 - High short circuit capability, self limiting if term. G is clamped to E
 - Pos. temp.-coeff. of V_{CEsat}
 - 50 % less turn off losses ⁹⁾
 - 30 % less short circuit current ⁹⁾
 - Very low C_{ies}, C_{oes}, C_{res} ⁹⁾
 - Latch-up free
 - Fast & soft inverse CAL diodes ⁸⁾
 - Isolated copper baseplate using DCB Direct Copper Bonding Technology without hard mould
 - Large clearance (13 mm) and creepage distances (20 mm)
- ### Typical Applications
- Switching (not for linear use)
 - Switched mode power supplies
 - AC inverter servo drives
 - UPS uninterruptable power supplies
 - Welding inverters

Characteristics		min.	typ.	max.	Units
Symbol	Conditions ¹⁾				
V _{(BR)CES}	V _{GE} = 0, I _C = 4 mA	≥ V _{CES}	–	–	V
V _{GE(th)}	V _{GE} = V _{CE} , I _C = 4 mA	4,5	5,5	6,5	V
I _{CES}	V _{GE} = 0 } T _j = 25 °C	–	2	6	mA
	V _{CE} = V _{CES} } T _j = 125 °C	–	12	–	mA
I _{GES}	V _{GE} = 20 V, V _{CE} = 0	–	–	1	μA
V _{CEsat}	I _C = 150 A } V _{GE} = 15 V;	–	1,8(2,0)	–	V
V _{CEsat}	I _C = 200 A } T _j = 25 (125) °C }	–	2,1(2,4)	2,5(2,8)	V
g _{fs}	V _{CE} = 20 V, I _C = 200 A	60	–	–	S
C _{CHC}	per IGBT	–	–	700	pF
C _{ies}	V _{GE} = 0	–	11,2	–	nF
C _{oes}	V _{CE} = 25 V	–	1250	–	pF
C _{res}	f = 1 MHz	–	750	–	pF
L _{CE}		–	–	20	nH
t _{d(on)}	V _{CC} = 300 V	–	140	–	ns
t _r	V _{GE} = -15 V / +15 V ³⁾	–	70	–	ns
t _{d(off)}	I _C = 200 A, ind. load	–	442	–	ns
t _f	R _{Gon} = R _{Goff} = 8 Ω	–	45	–	ns
E _{on}	T _j = 125 °C	–	11	–	mWs
E _{off}		–	7,5	–	mWs
Inverse Diode ⁸⁾					
V _F = V _{EC}	I _F = 150 A } V _{GE} = 0 V;	–	1,45(1,35)	1,7	V
V _F = V _{EC}	I _F = 200 A } T _j = 25 (125) °C }	–	1,55(1,55)	1,9	V
V _{TO}	T _j = 125 °C	–	–	0,9	V
r _t	T _j = 125 °C	–	4	5,5	mΩ
I _{RRM}	I _F = 200 A; T _j = 125 °C ²⁾	–	75	–	A
Q _{rr}	I _F = 200 A; T _j = 125 °C ²⁾	–	12,7	–	μC
Thermal characteristics					
R _{thjc}	per IGBT	–	–	0,14	°C/W
R _{thjc}	per diode	–	–	0,3	°C/W
R _{thch}	per module	–	–	0,038	°C/W

¹⁾ T_{case} = 25 °C, unless otherwise specified

²⁾ I_F = - I_C, V_R = 300 V, -di_F/dt = 1500 A/μs, V_{GE} = 0 V

³⁾ Use V_{GEoff} = - 5 ... - 15 V

⁸⁾ CAL = Controlled Axial Lifetime Technology

⁹⁾ Compared to PT-IGBT

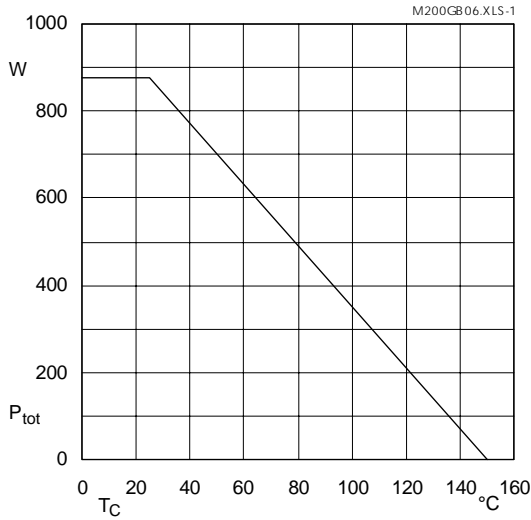

Fig. 1 Rated power dissipation $P_{tot} = f(T_C)$

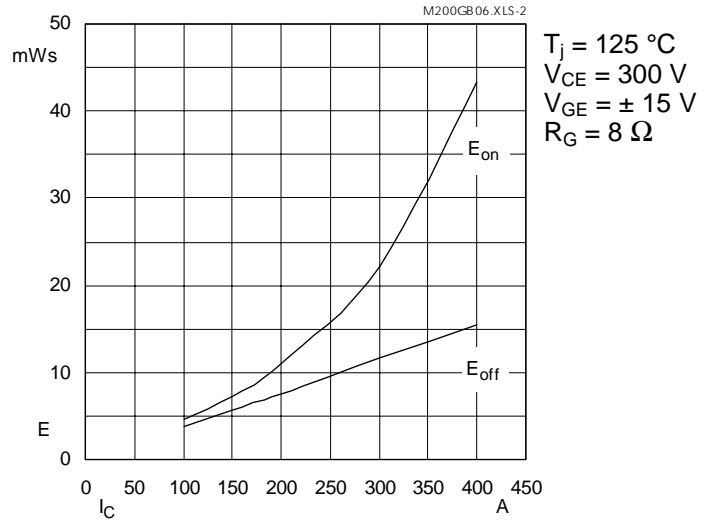

Fig. 2 Turn-on /-off energy $= f(I_C)$

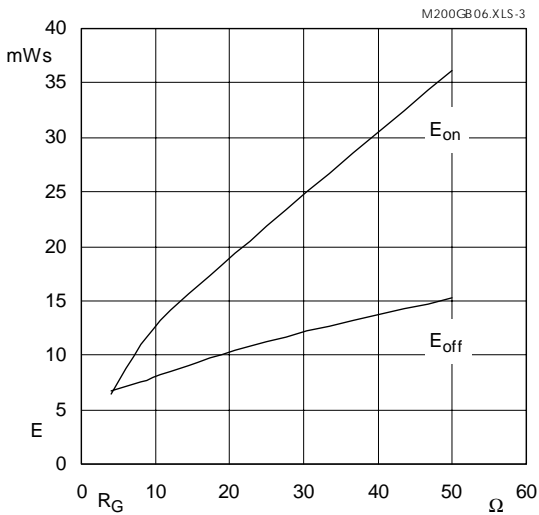

Fig. 3 Turn-on /-off energy $= f(R_G)$

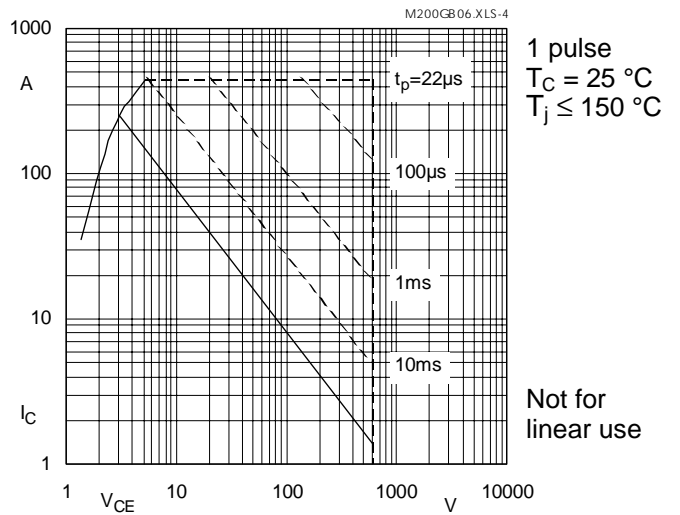

Fig. 4 Maximum safe operating area (SOA) $I_C = f(V_{CE})$

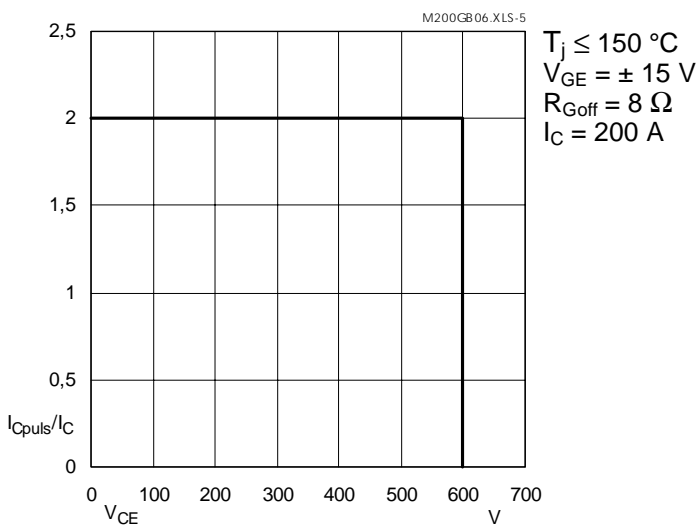

Fig. 5 Turn-off safe operating area (RBSOA)

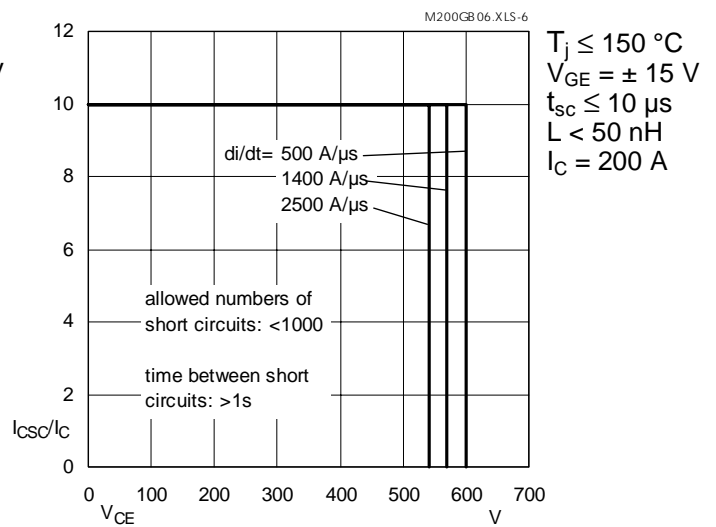

Fig. 6 Safe operating area at short circuit $I_C = f(V_{CE})$

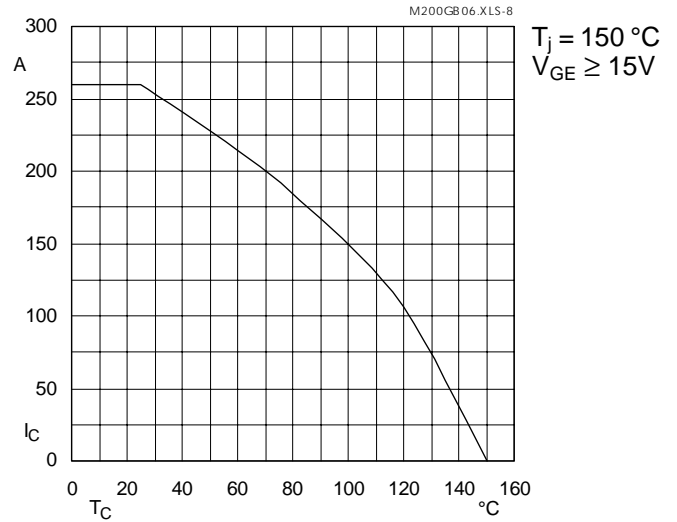

Fig. 8 Rated current vs. temperature $I_C = f(T_C)$

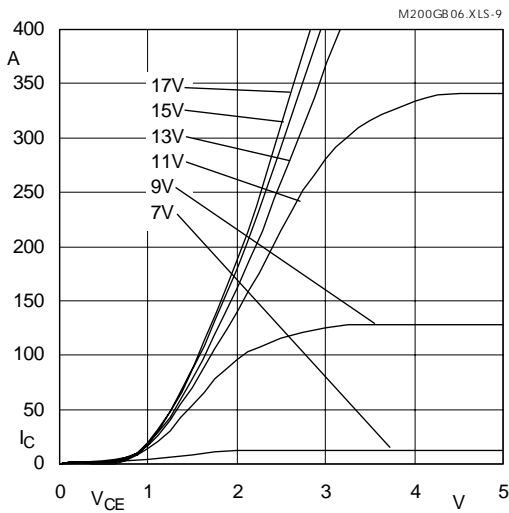

Fig. 9 Typ. output characteristic, $t_p = 250 \mu s$; $T_j = 25 \text{ }^\circ\text{C}$

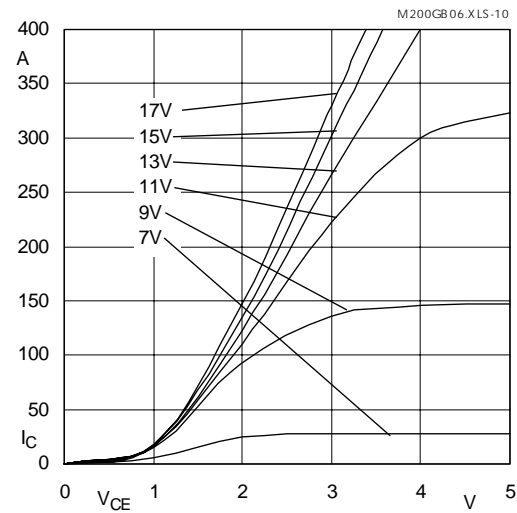

Fig. 10 Typ. output characteristic, $t_p = 250 \mu s$; $T_j = 125 \text{ }^\circ\text{C}$

$$P_{\text{cond}(t)} = V_{\text{CEsat}(t)} \cdot I_{\text{C}(t)}$$

$$V_{\text{CEsat}(t)} = V_{\text{CE(TO)(T}_j)} + r_{\text{CE(T}_j)} \cdot I_{\text{C}(t)}$$

$$V_{\text{CE(TO)(T}_j)} \leq 1,2 - 0,001 (T_j - 25) \text{ [V]}$$

$$\text{typ.: } r_{\text{CE(T}_j)} = 0,0045 + 0,00002 (T_j - 25) \text{ [\Omega]}$$

$$\text{max.: } r_{\text{CE(T}_j)} = 0,0065 + 0,00002 (T_j - 25) \text{ [\Omega]}$$

$$\text{valid for } V_{\text{GE}} = +15_{-1}^{+2} \text{ [V]; } I_{\text{C}} \geq 0,3 I_{\text{Cn}}$$

Fig. 11 Saturation characteristic (IGBT)
Calculation elements and equations

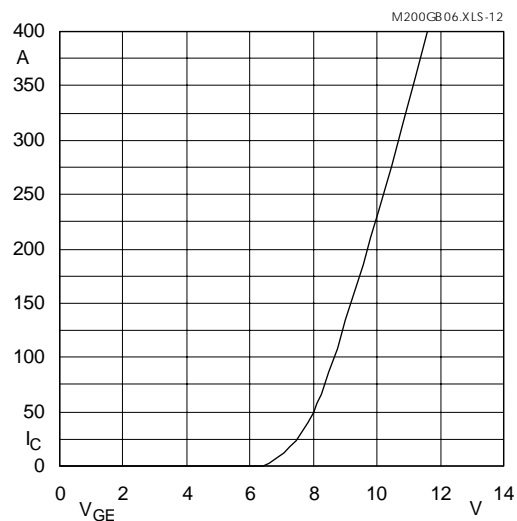

Fig. 12 Typ. transfer characteristic, $t_p = 250 \mu s$; $V_{\text{CE}} = 20 \text{ V}$

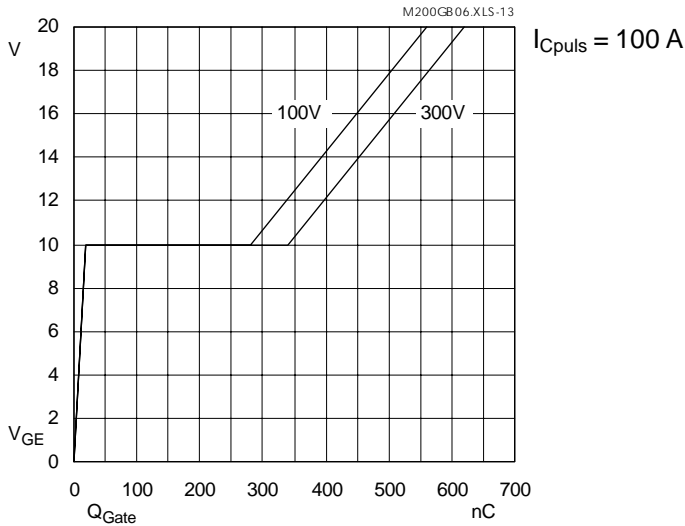

Fig. 13 Typ. gate charge characteristic

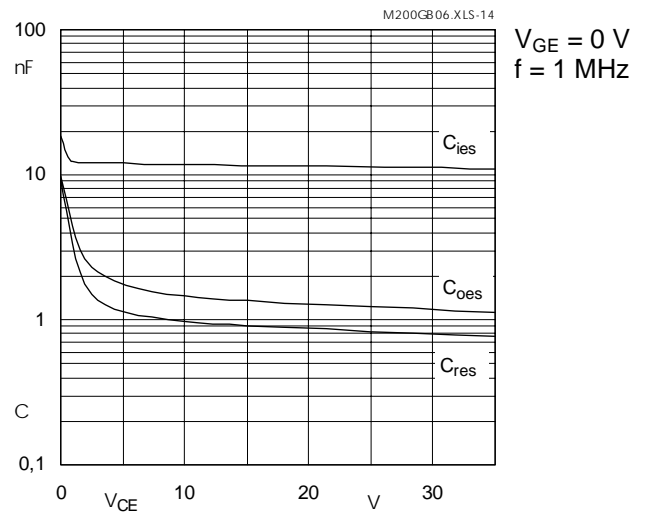

Fig. 14 Typ. capacitances vs. V_{CE}

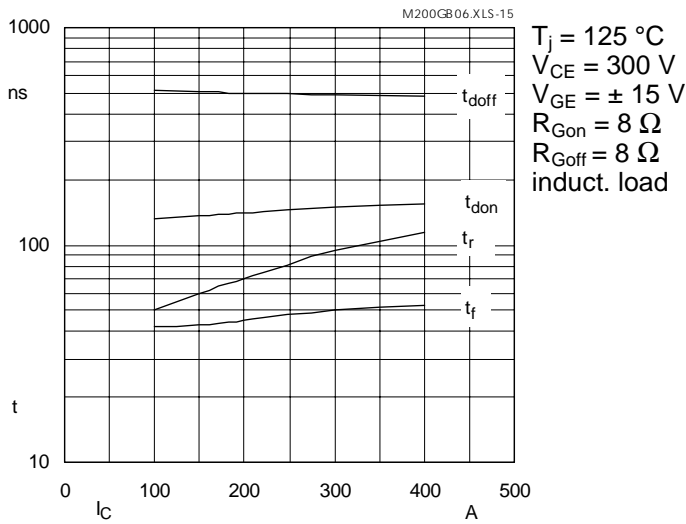

Fig. 15 Typ. switching times vs. I_C

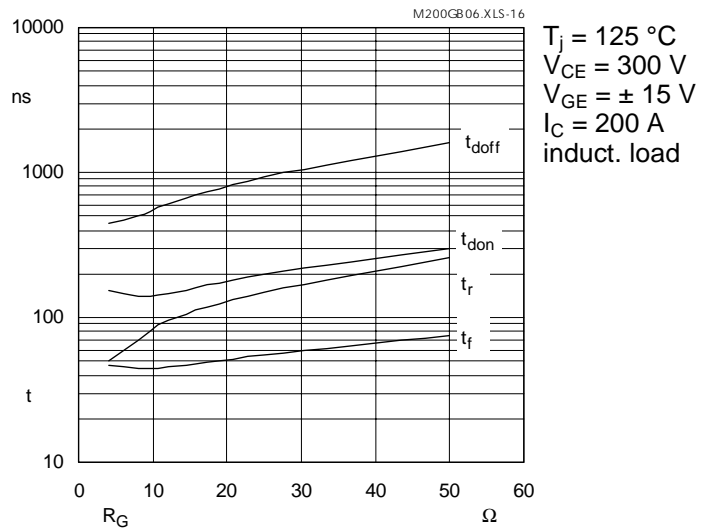

Fig. 16 Typ. switching times vs. gate resistor R_G

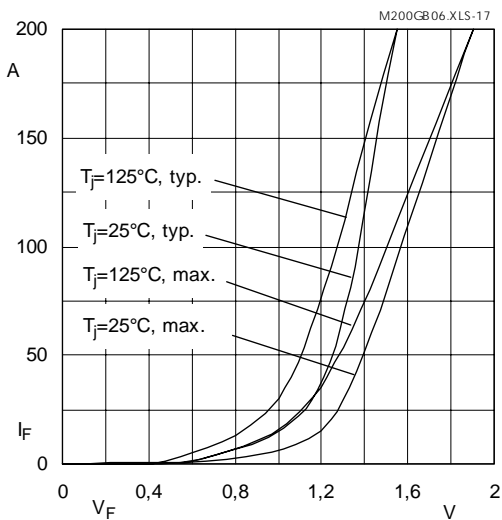

Fig. 17 Typ. CAL diode forward characteristic

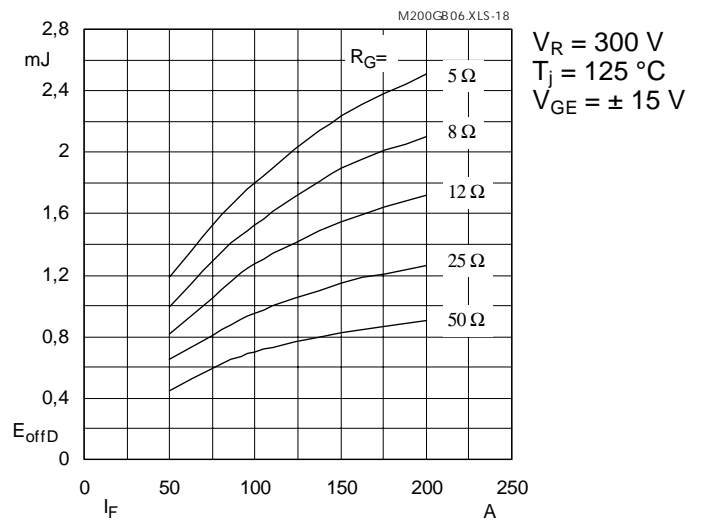

Fig. 18 Diode turn-off energy dissipation per pulse

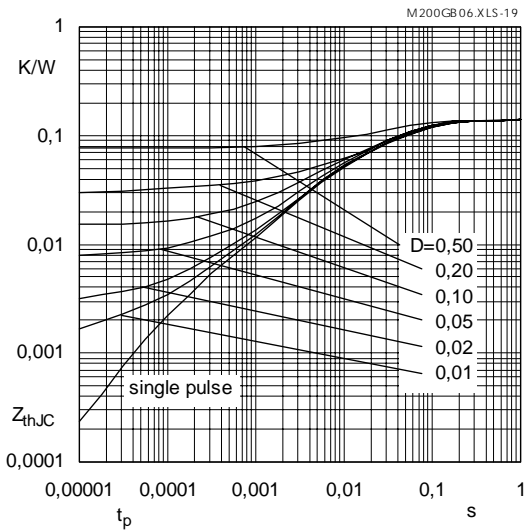

Fig. 19 Transient thermal impedance of IGBT
 $Z_{thJC} = f(t_p)$; $D = t_p / t_c = t_p \cdot f$

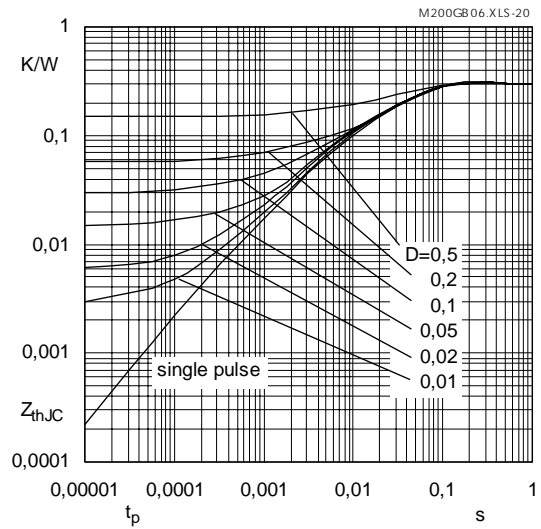

Fig. 20 Transient thermal impedance of inverse CAL diodes
 $Z_{thJC} = f(t_p)$; $D = t_p / t_c = t_p \cdot f$

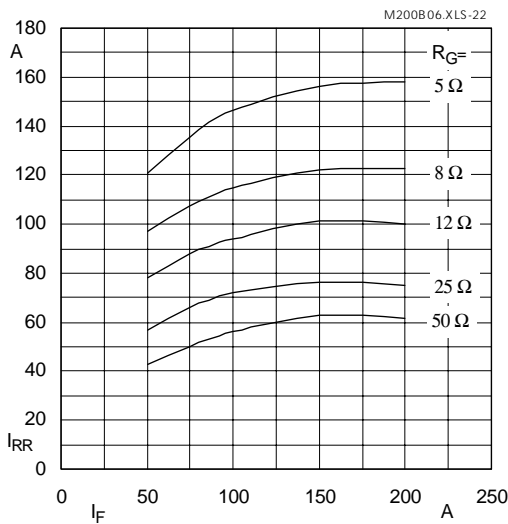

Fig. 22 Typ. CAL diode peak reverse recovery current $I_{RR} = f(I_F; R_G)$

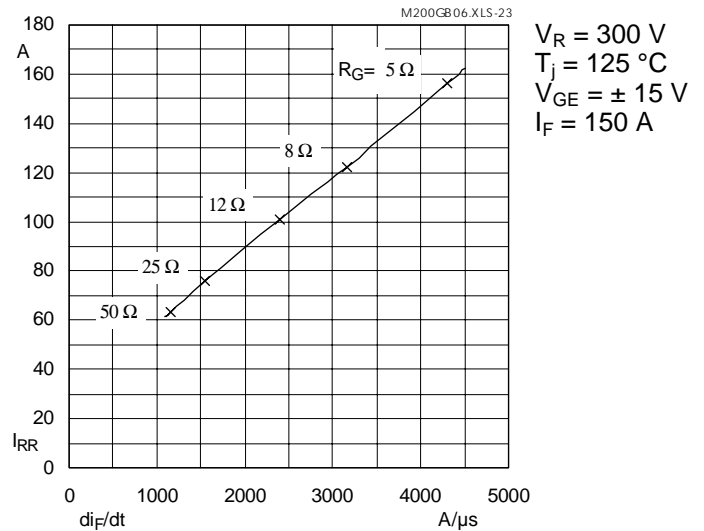

Fig. 23 Typ. CAL diode peak reverse recovery current $I_{RR} = f(di/dt)$

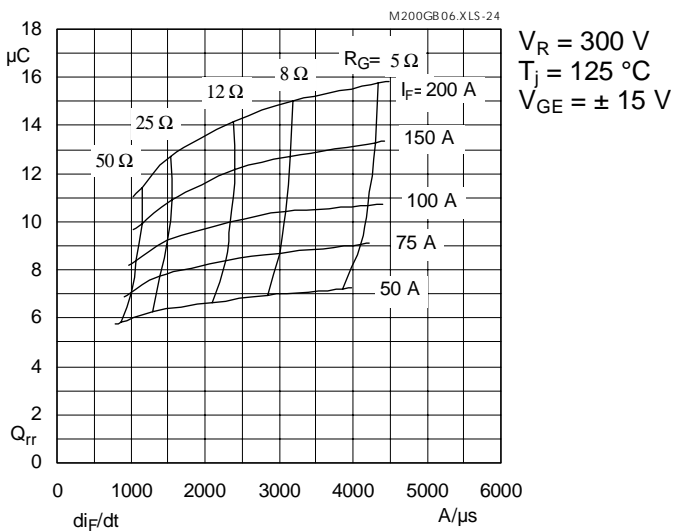

Fig. 24 Typ. CAL diode recovered charge

SEMITRANS 3

Case D 56

UL Recognized

File no. E 63 532

CASED56

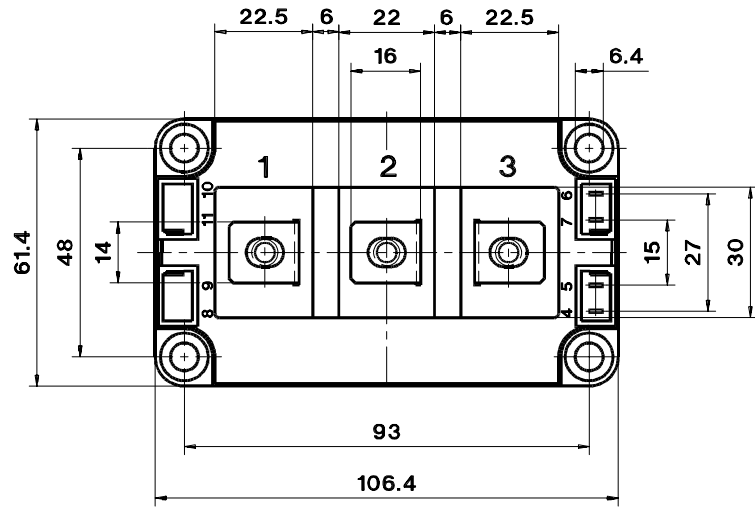
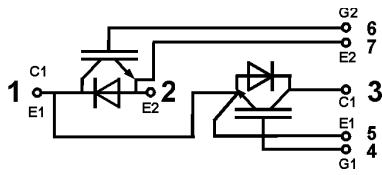
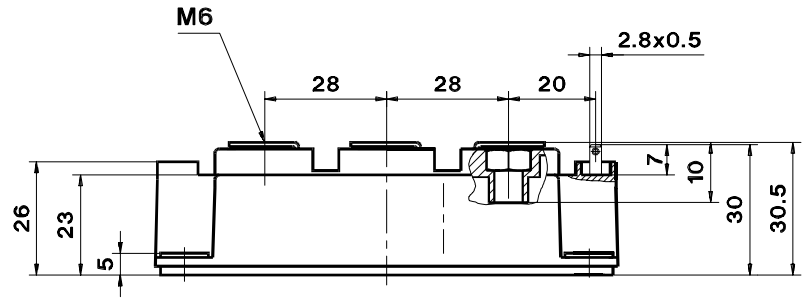

Dimensions in mm

Case outline and circuit diagram

Mechanical Data		Values			Units
Symbol	Conditions	min.	typ.	max.	
M ₁	to heatsink, SI Units(M6)	3	—	5	Nm
	to heatsink, US Units	27	—	44	lb.in.
M ₂	for terminals, SI Units(M6)	2,5	—	5	Nm
	for terminals, US Units	22	—	44	lb.in.
a		—	—	5x9,81	m/s ²
w		—	—	325	g

This is an electrostatic discharge sensitive device (ESDS).

Please observe the international standard IEC 747-1, Chapter IX.

Eight devices are supplied in one SEMIBOX A without mounting hardware, which can be ordered separately under Ident No. 33321100 (for 10 SEMITRANS 3) Larger packing units of 12 or 20 pieces are used if suitable
 Accessories → B 6 – 4
 SEMIBOX → C - 1.