

$I_{F(AV)} = 19\text{Amp}$
 $V_R = 15\text{V}$

Major Ratings and Characteristics

Characteristics	19TQ015	Units
$I_{F(AV)}$ Rectangular waveform	19	A
V_{RRM}	15	V
I_{FSM} @tp = 5 μ s sine	700	A
V_F @19Apk, $T_J = 75^\circ\text{C}$	0.32	V
T_J range	-55 to 125	$^\circ\text{C}$

Description/Features

The 19TQ015 Schottky rectifier has been optimized for ultra low forward voltage drop specifically for the OR-ing of parallel power supplies. The proprietary barrier technology allows for reliable operation up to 125 $^\circ$ C junction temperature. Typical applications are in parallel switching power supplies, converters, reverse battery protection, and redundant power subsystems.

- 125 $^\circ\text{C}$ T_J operation ($V_R < 5\text{V}$)
- Optimized for OR-ing applications
- Ultra low forward voltage drop
- High frequency operation
- Guard ring for enhanced ruggedness and long term reliability
- High purity, high temperature epoxy encapsulation for enhanced mechanical strength and moisture resistance

Case Styles

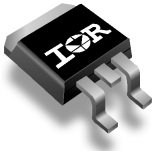
<p>19TQ015</p>  <p>TO-220</p>	<p>19TQ015S</p>  <p>D²PAK</p>
--	--

Voltage Ratings

Part number	19TQ015
V_R Max. DC Reverse Voltage (V)	15
V_{RMM} Max. Working Peak Reverse Voltage (V)	

Absolute Maximum Ratings

Parameters	19TQ	Units	Conditions
$I_{F(AV)}$ Max. Average Forward Current * See Fig. 5	19	A	50% duty cycle @ $T_C = 80^\circ\text{C}$, rectangular wave form
I_{FSM} Max. Peak One Cycle Non-Repetitive Surge Current * See Fig. 7	700	A	5 μs Sine or 3 μs Rect. pulse
	330		10ms Sine or 6ms Rect. pulse
E_{AS} Non-Repetitive Avalanche Energy	6.75	mJ	$T_J = 25^\circ\text{C}$, $I_{AS} = 1.50$ Amps, $L = 6$ mH
I_{AR} Repetitive Avalanche Current	1.50	A	Current decaying linearly to zero in 1 μsec Frequency limited by T_J max. $V_A = 3 \times V_R$ typical

Electrical Specifications

Parameters	19TQ	Units	Conditions
V_{FM} Max. Forward Voltage Drop (1) * See Fig. 1	0.36	V	@ 19A
	0.46	V	@ 38A
	0.32	V	@ 19A
	0.43	V	@ 38A
I_{RM} Max. Reverse Leakage Current (1) * See Fig. 2	10.5	mA	$T_J = 25^\circ\text{C}$
	522	mA	$T_J = 100^\circ\text{C}$
	465	mA	$T_J = 100^\circ\text{C}$, $V_R = 12\text{V}$
	285	mA	$T_J = 100^\circ\text{C}$, $V_R = 5\text{V}$
C_T Max. Junction Capacitance	2000	pF	$V_R = 5V_{DC}$, (test signal range 100Khz to 1Mhz) 25°C
L_S Typical Series Inductance	8.0	nH	Measured lead to lead 5mm from package body
dv/dt Max. Voltage Rate of Change (Rated V_R)	10,000	V/ μs	

(1) Pulse Width < 300 μs , Duty Cycle < 2%

Thermal-Mechanical Specifications

Parameters	19TQ	Units	Conditions
T_J Max. Junction Temperature Range	-55 to 125	$^\circ\text{C}$	
T_{stg} Max. Storage Temperature Range	-55 to 150	$^\circ\text{C}$	
R_{thJC} Max. Thermal Resistance Junction to Case	1.50	$^\circ\text{C}/\text{W}$	DC operation * See Fig. 4
R_{thCS} Typical Thermal Resistance, Case to Heatsink	0.50	$^\circ\text{C}/\text{W}$	Mounting surface, smooth and greased
wt Approximate Weight	2(0.07)	g(oz.)	
T Mounting Torque	Min.	6(5)	Kg-cm (lbf-in)
	Max.	12(10)	

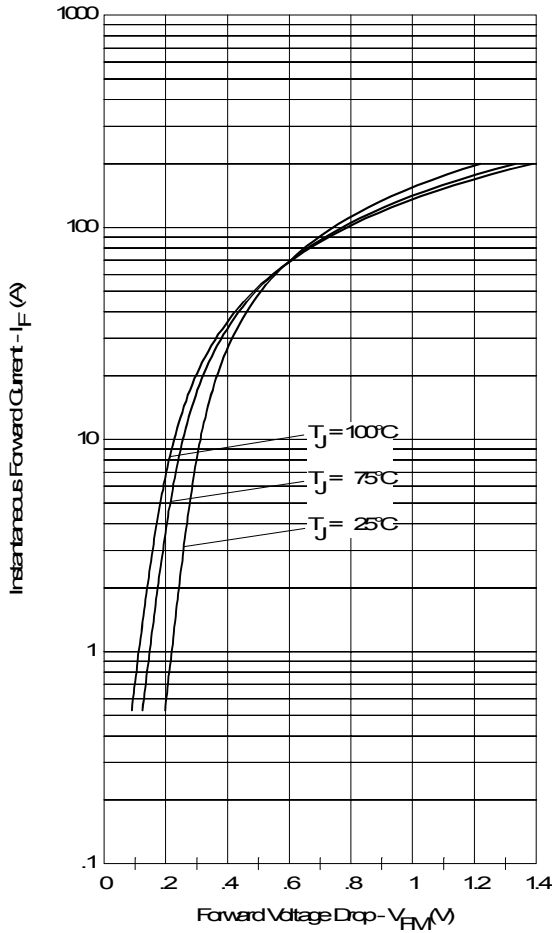

Fig. 1 - Maximum Forward Voltage Drop Characteristics

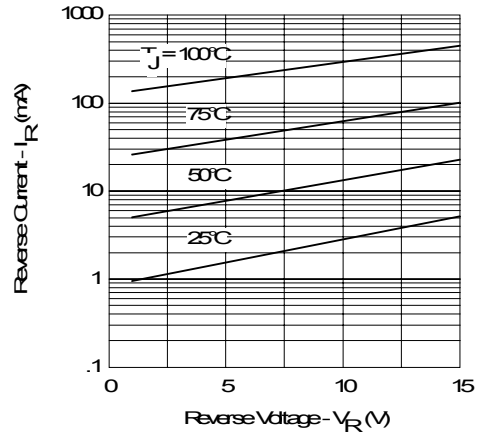

Fig. 2 - Typical Values of Reverse Current Vs. Reverse Voltage

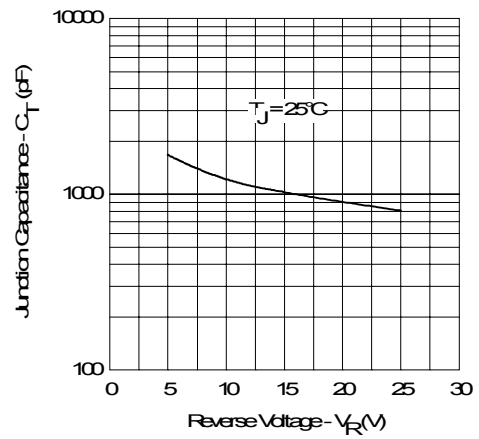

Fig. 3 - Typical Junction Capacitance Vs. Reverse Voltage

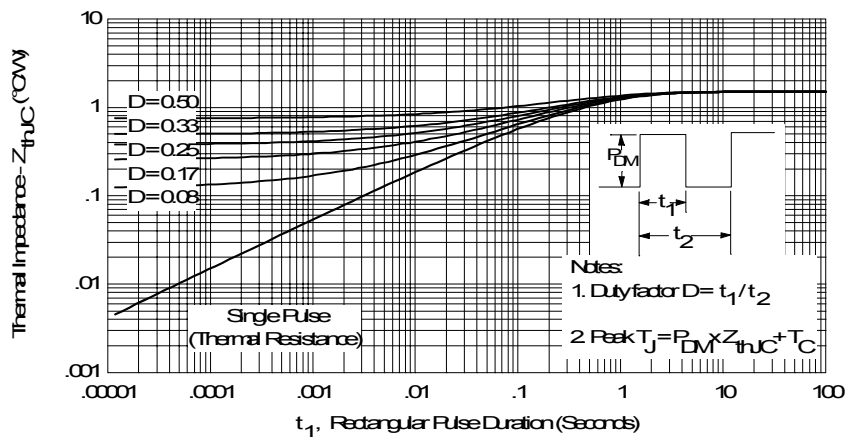

Fig. 4 - Maximum Thermal Impedance Z_{thJC} Characteristics

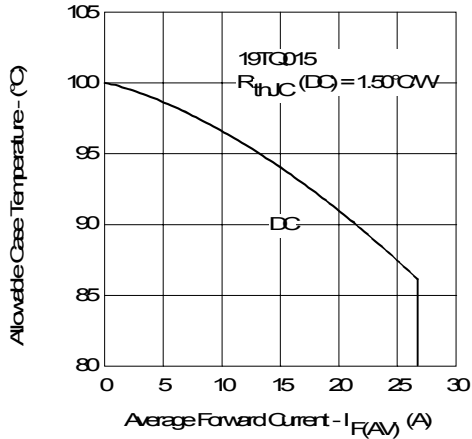

Fig. 5- Maximum Allowable Case Temperature Vs. Average Forward Current

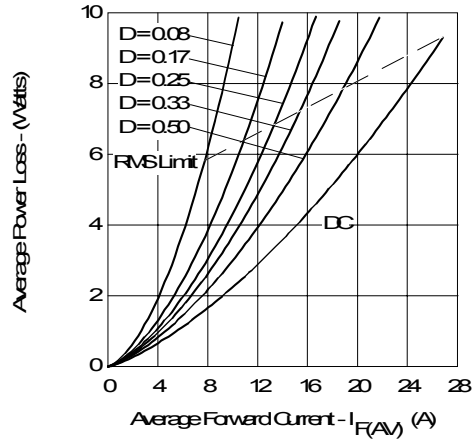

Fig. 6- Forward Power Loss Characteristics

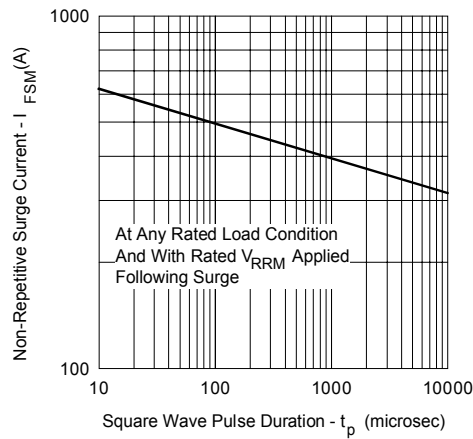

Fig. 7- Maximum Non-Repetitive Surge Current

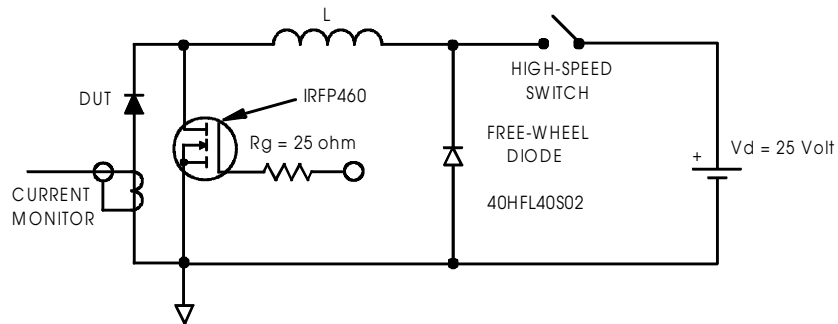
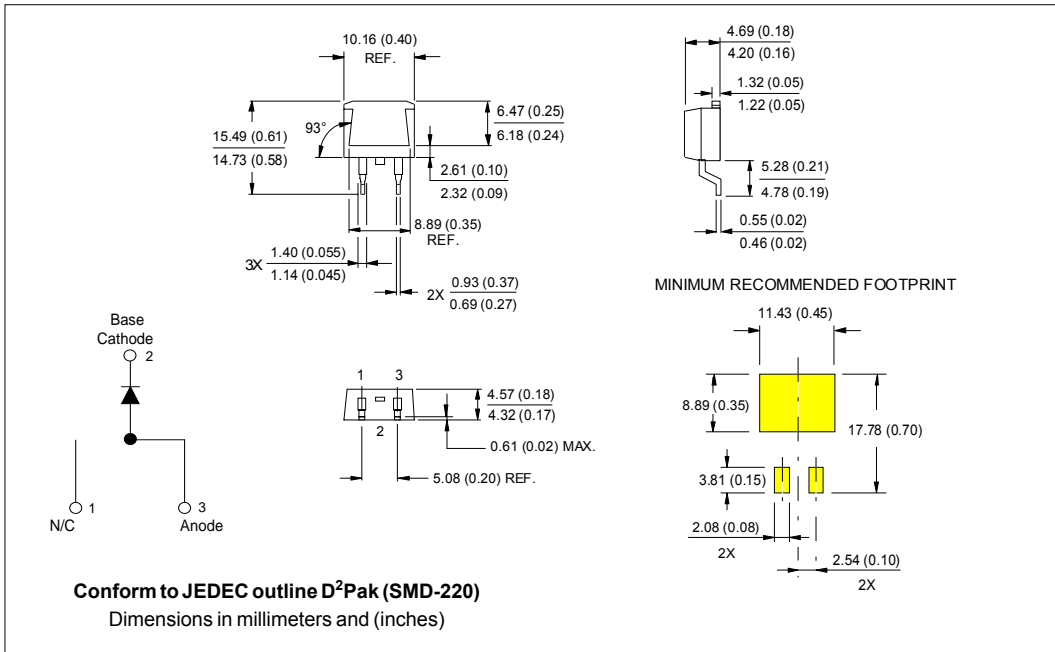
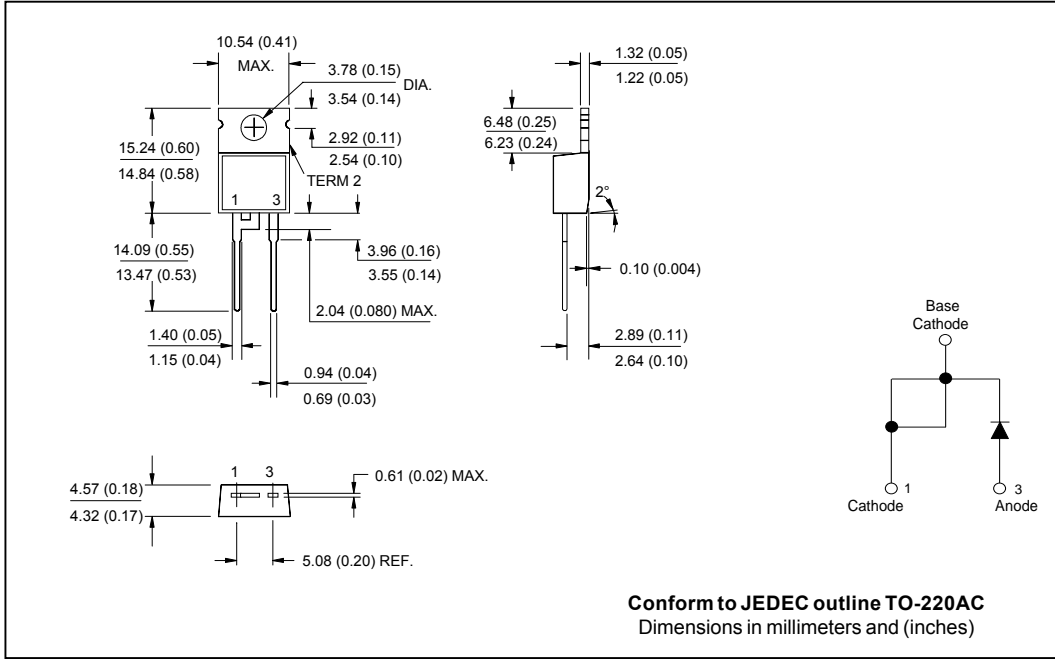

Fig. 8- Unclamped Inductive Test Circuit

Outline Table



Ordering Information Table

