

SCHOTTKY RECTIFIER

1 Amp

Major Ratings and Characteristics

Characteristics	10BQ060	Units
$I_{F(AV)}$ Rectangular waveform	1.0	A
V_{RRM}	60	V
I_{FSM} @ $t_p = 5\mu s$ sine	700	A
V_F @ 1.0Apk, $T_J = 125^\circ C$	0.54	V
T_J	-55 to 150	$^\circ C$

Description / Features

The 10BQ060 surface-mount Schottky rectifier has been designed for applications requiring very low forward drop and small foot prints on PC boards. Typical applications are in disk drives, switching power supplies, converters, free-wheeling diodes, battery charging and reverse battery protection.

- Small footprint, surface mountable
- Very low forward voltage drop
- High frequency operation
- Guard ring for enhanced ruggedness and long-term reliability

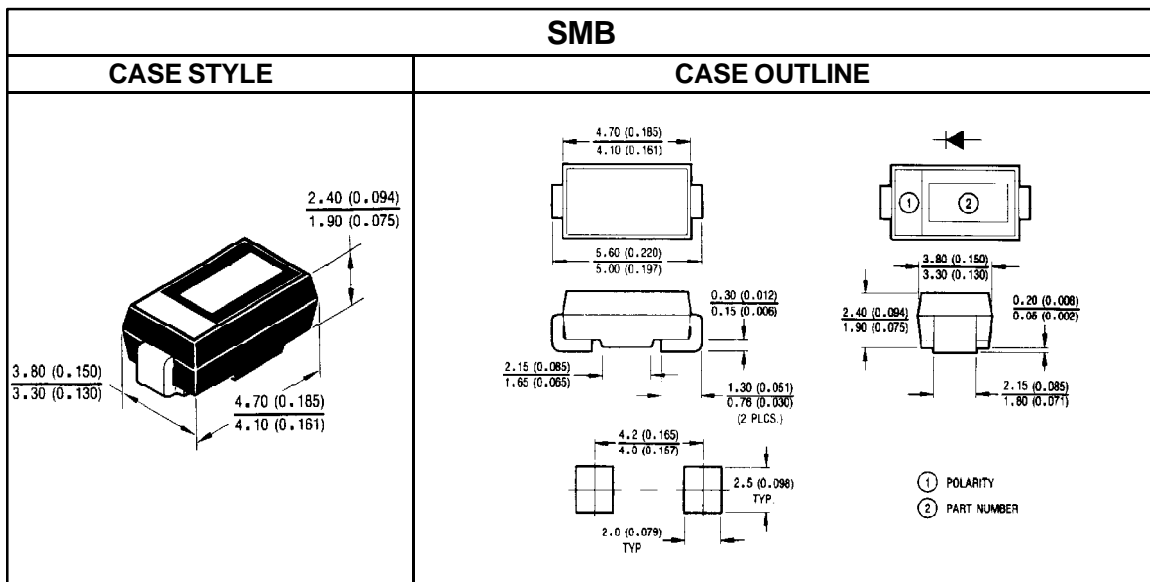

10BQ060



Voltage Ratings

Part number	10BQ060
V_R Max. DC Reverse Voltage (V)	60
V_{RWM} Max. Working Peak Reverse Voltage (V)	

Absolute Maximum Ratings

Parameters		10BQ	Units	Conditions
$I_{F(AV)}$	Max. Average Forward Current See Fig. 5	1.0	A	50% duty cycle @ $T_C = 103^\circ\text{C}$, rectangular waveform
I_{FSM}	Max. Peak One Cycle Non - Repetitive Surge Current — see Fig. 7	700	A	5 μs Sine or 3 μs Rect. pulse 10ms Sine or 6ms Rect. pulse Following any rated load condition and with rated V_{RWM} applied.
		42		
E_{AS}	Non - Repetitive Avalanche Energy	11	mJ	$T_J = 25^\circ\text{C}$, $I_{AS} = 1.0\text{A}$, $L = 4.0\text{mH}$
I_{AR}	Repetitive Avalanche Current	1.0	A	Current decaying linearly to zero in 1 μsec Frequency limited by T_J max. $V_A = 1.5 \times V_R$ typical

Electrical Specifications

Parameters		10BQ	Units	Conditions
V_{FM}	Max. Forward Voltage Drop See Fig. 1 ①	0.57	V	@ 1.0A
		0.73	V	@ 2.0A
		0.54	V	@ 1.0A
		0.66	V	@ 2.0A
I_{RM}	Max. Reverse Leakage Current ① See Fig. 2	0.1	mA	$T_J = 25^\circ\text{C}$
		5.0	mA	$T_J = 125^\circ\text{C}$
C_T	Max. Junction Capacitance	62	pF	$V_R = 5V_{DC}$, (test signal range 100KHz to 1MHz) 25°C
L_S	Typical Series Inductance	2.0	nH	Measured lead to lead 5mm from package body
dv/dt	Max. Voltage Rate of Change (Rated V_R)	10,000	V/ μs	

Thermal-Mechanical Specifications

Parameters		10BQ	Units	Conditions
T_J	Max. Junction Temperature Range	-55 to 150	$^\circ\text{C}$	
T_{STG}	Max. Storage Temperature Range	-55 to 150	$^\circ\text{C}$	
R_{thJA}	Max. Thermal Resistance, Junction to Ambient	140	$^\circ\text{C}/\text{W}$	DC operation — See Fig. 4
R_{thJL}	Max. Thermal Resistance, Junction to Lead ②	36	$^\circ\text{C}/\text{W}$	DC operation
wt	Approximate Weight	0.10	g	
Case Style		SMB		Similar to DO-214AA

① Pulse Width < 300 μs , Duty Cycle < 2%

② Mounted 1 inch square PCB, thermal probe connected to lead 2mm from package

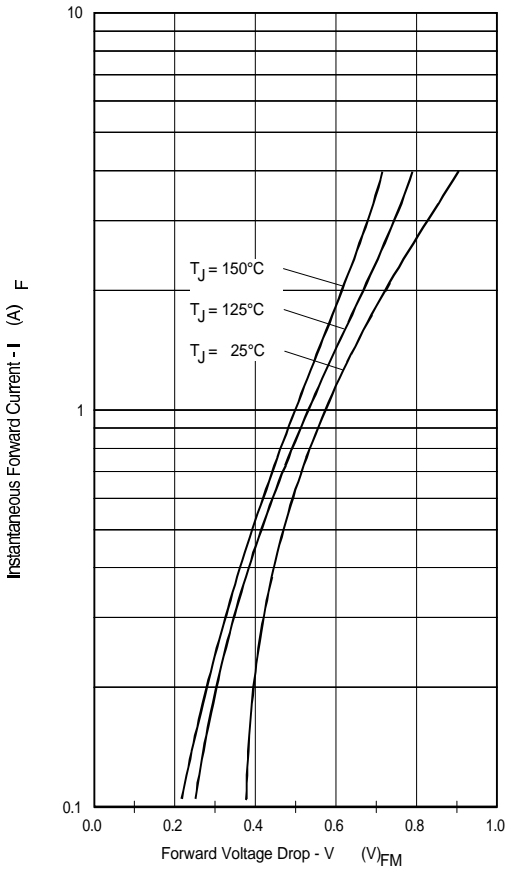

Fig. 1 Max. Forward Voltage Drop Characteristics

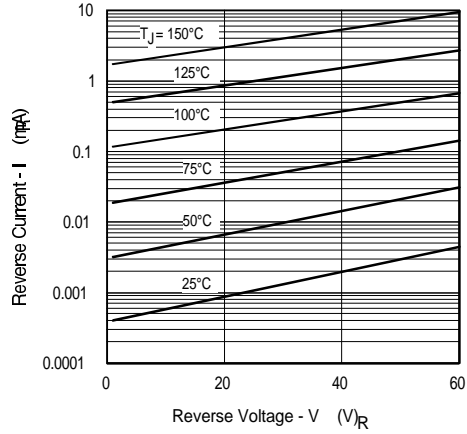

Fig. 2 Typical Values of Reverse Current Vs. Reverse Voltage

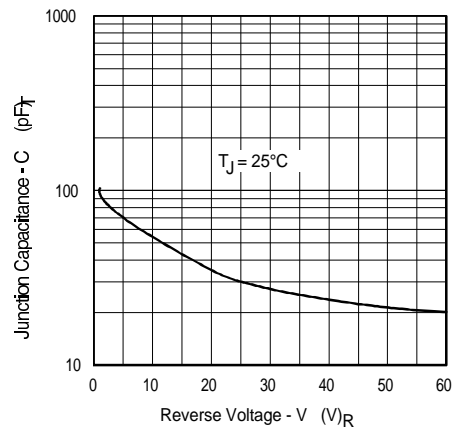

Fig. 3 Typical Junction Capacitance Vs. Reverse Voltage

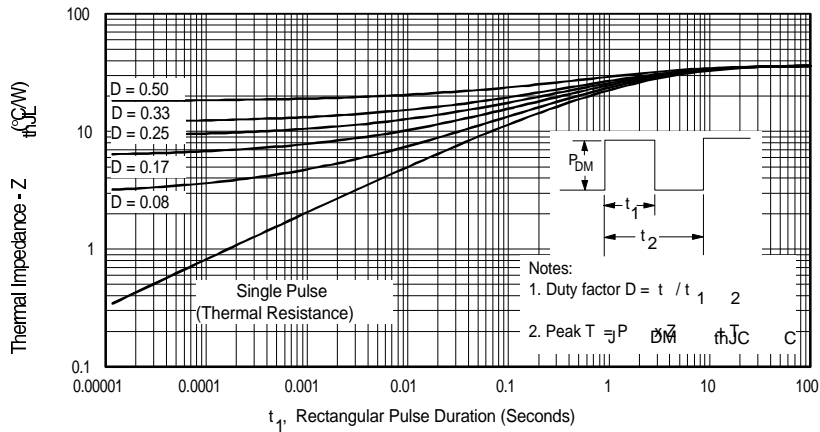

Fig. 4 Max. Thermal Impedance Z_{thJL} Characteristics

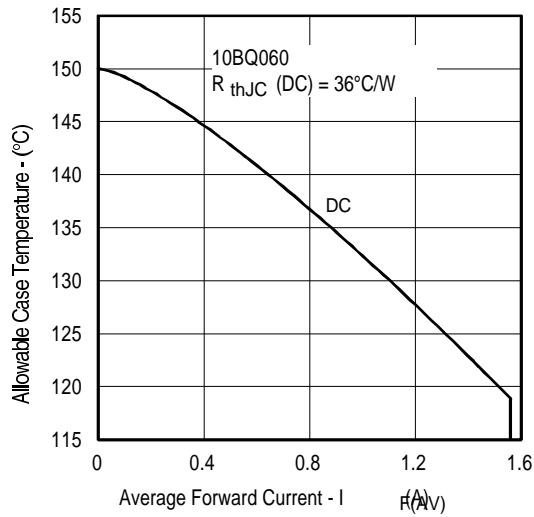

Fig. 5 Max. Allowable Case Temperature Vs. Average Forward Current

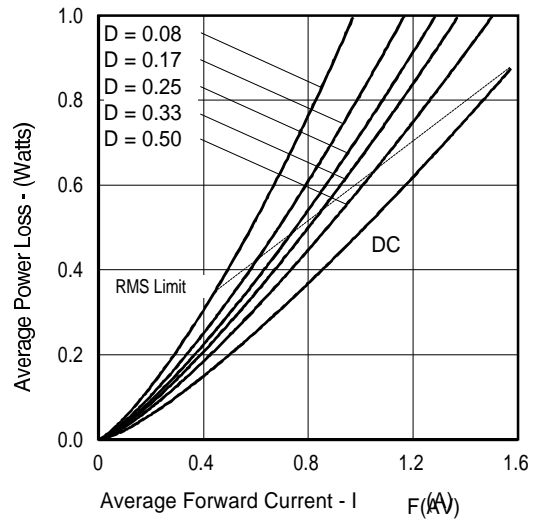

Fig. 6 Forward Power Loss Characteristics

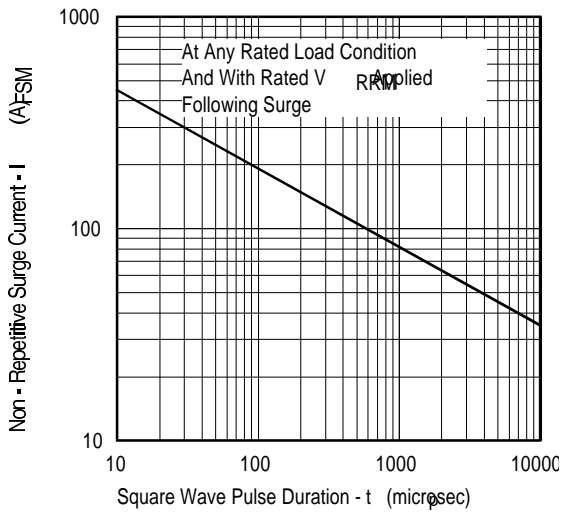

Fig.7 Max. Non-Repetitive Surge Current

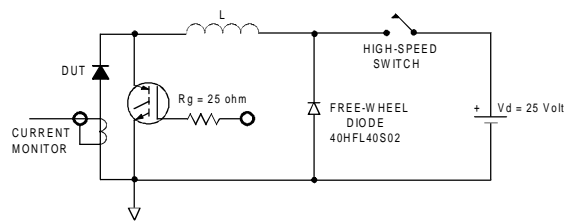
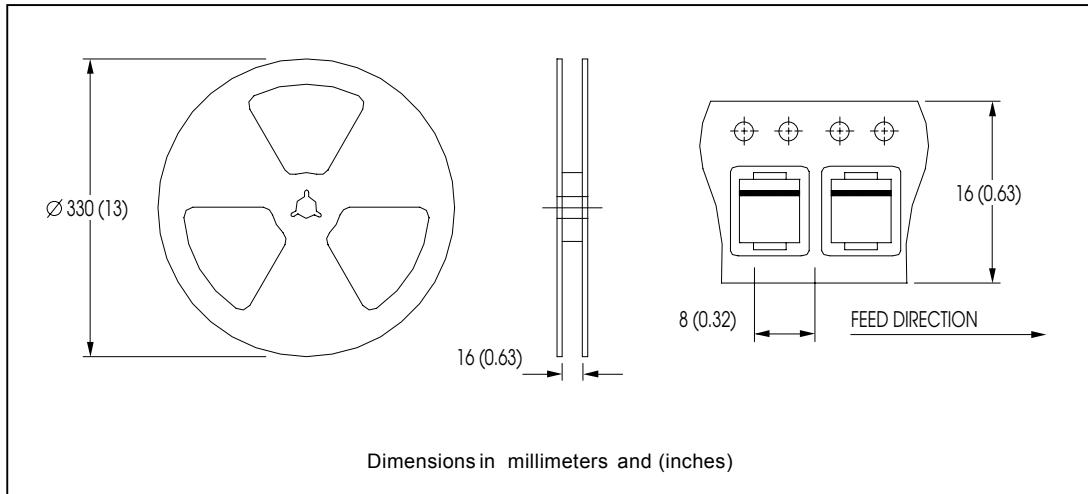

Fig. 8 Unclamped Inductive Test Circuit



10BQ060

Tape & Reel Information



Marking & Identification

Each device has 4 characters, configured two digits on two rows, for identification. The first row designates the device as manufactured by International Rectifier as indicated by the letters "IR". The second row indicates the current rating and voltage/process. See the drawing below for marking code.

FIRST ROW

IR

SECOND ROW

1st DIGIT = CURRENT RATING
2nd DIGIT = VOLTAGE/PROCESS

EXAMPLE: IR — INTERNATIONAL RECTIFIER
1F — 40 VOLT/STANDARD PROCESS
1 AMP

1st DIGIT	2nd DIGIT
CURRENT	VOLTAGE/PROCESS
1 = 1 AMP	C = 15 VOLTS
	E = 30 VOLTS
	F = 40 VOLTS
	H = 60 VOLTS
	J = 100 VOLTS

Ordering Information

10BQ SERIES - TAPE AND REEL

WHEN ORDERING, INDICATE THE PART NUMBER AND THE QUANTITY (IN MULTIPLES OF 3000 PIECES).

EXAMPLE: 10BQ060TR - 6000 PIECES

10BQ SERIES - BULK QUANTITIES

WHEN ORDERING, INDICATE THE PART NUMBER AND THE QUANTITY (IN MULTIPLES OF 1000 PIECES).

EXAMPLE: 10BQ060 - 2000 PIECES

10BQ060



International
IOR Rectifier

WORLD HEADQUARTERS: 233 Kansas St., El Segundo, California 90245 U.S.A. Tel: (310) 322 3331. Fax: (310) 322 3332.
EUROPEAN HEADQUARTERS: Hurst Green, Oxted, Surrey RH8 9BB, U.K. Tel: ++ 44 1883 732020. Fax: ++ 44 1883 733408.
IR CANADA: 15 Lincoln Court, Brampton, Markham, Ontario L6T3Z2. Tel: (905) 453 2200. Fax: (905) 475 8801.
IR GERMANY: Saalburgstrasse 157, 61350 Bad Homburg. Tel: ++ 49 6172 96590. Fax: ++ 49 6172 965933.
IR ITALY: Via Liguria 49, 10071 Borgaro, Torino. Tel: ++ 39 11 4510111. Fax: ++ 39 11 4510220.
IR FAR EAST: K&H Bldg., 2F, 30-4 Nishi-Ikebukuro 3-Chome, Toshima-Ku, Tokyo, Japan 171. Tel: 81 3 3983 0086.
IR SOUTHEAST ASIA: 1 Kim Seng Promenade, Great World City West Tower, 13-11, Singapore 237994. Tel: ++ 65 838 4630.
IR TAIWAN: 16 Fl. Suite D.207, Sec. 2, Tun Haw South Road, Taipei, 10673, Taiwan. Tel: 886 2 2377 9936.

<http://www.irf.com>

Fax-On-Demand: +44 1883 733420

Data and specifications subject to change without notice.
